

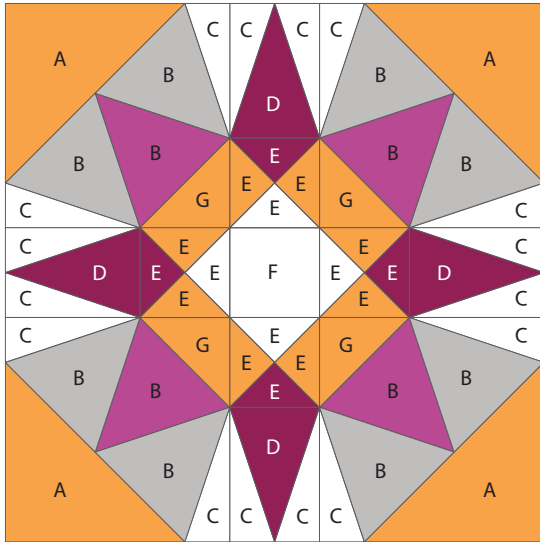

GO!® North Carolina Star-12" Finished

Item Number: 55605

Fabric Cutting Tips for a 5-colour, 12" finished North Carolina Star block:



For best cutting results, position fabric on the lengthwise grain (straight of grain) as it goes under the roller. Tip: The die is specially designed to cut one complete 5-colour 12" finished block in one pass through the cutter.

- Fabric Colour 1 (orange):**
 - Cut A and G shapes together. Cut two $5\frac{3}{8}$ " x $8\frac{1}{2}$ " rectangles. Place right side up over shapes A and G to cut four of each shape.
 - Cut two $3\frac{3}{4}$ " squares. Place right side up over shapes E to cut eight shapes.
- Fabric Colour 2 (gray):** Cut four $6\frac{5}{8}$ " x $4\frac{1}{4}$ " rectangles. Place right side up over shapes B to cut eight shapes.
- Fabric Colour 3 (purple):** Cut two $6\frac{5}{8}$ " x $4\frac{1}{4}$ " rectangles. Place right side up over shapes B to cut four shapes.
- Fabric Colour 4 (white):**
 - Cut two $4\frac{1}{2}$ " x $8\frac{1}{2}$ " rectangles. Fanfold into four layers and place over shapes C to cut eight mirrored half rectangle triangle sets.
 - Cut one $3\frac{3}{4}$ " square. Place right side up over shapes E to cut four shapes.
 - Cut one 3" square. Place right side up over shape F to cut one shape.
- Fabric Colour 5 (dark purple):**
 - Cut four 3" x 4" rectangles. Place right side up over shape D to cut four shapes.
 - Cut one $3\frac{3}{4}$ " square. Place right side up over shapes E to cut four shapes.

Shapes needed for 12" finished North Carolina Star

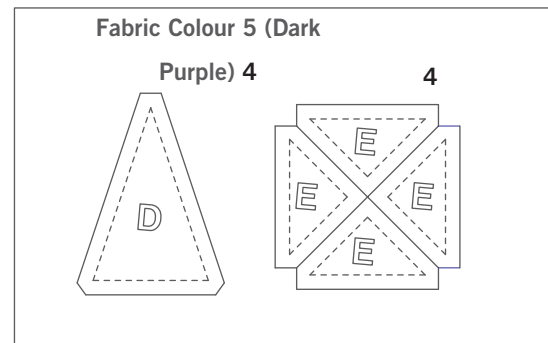
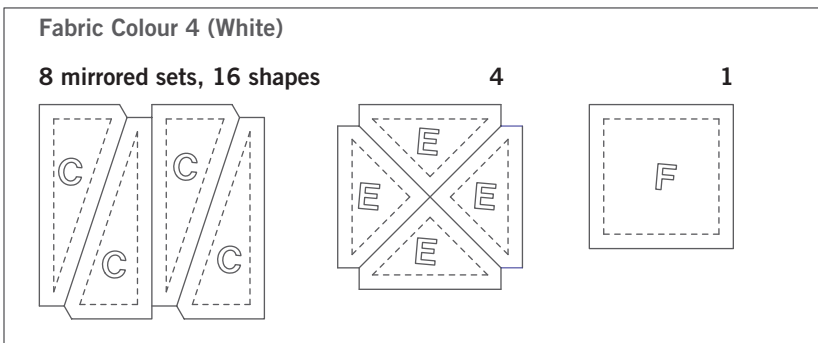
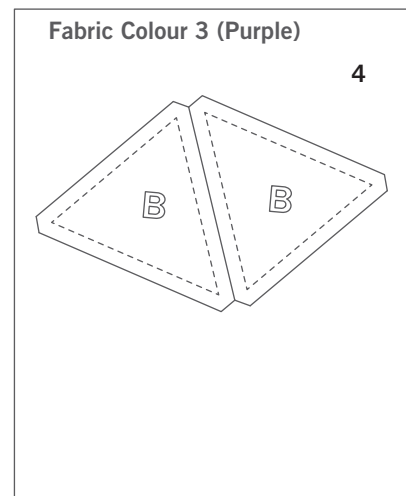
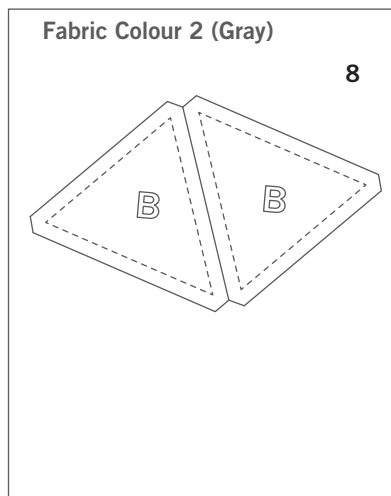
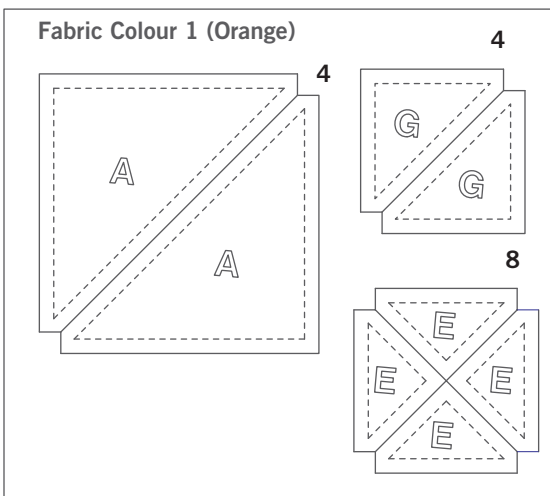



GO!® North Carolina Star-12" Finished

Item Number: 55605

How to Sew the 5-colour, 12" finished North Carolina Star: Use a ¼" seam allowance. Press as directed.

Step 1

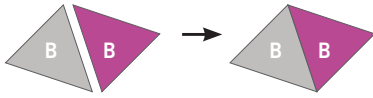

Sew two B pieces together to create B/B units as shown. Make 4 units.

Step 2

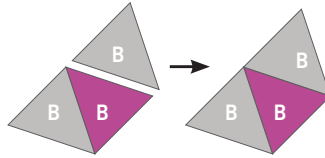

Sew a third B piece as shown to make a B/B/B unit. Make 4 units.

Step 3

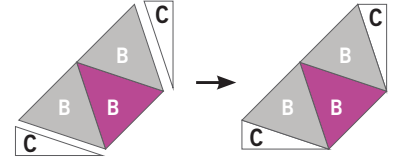

Sew a C piece to either side of the B/B/B unit as shown. Make 4 units.

Step 4

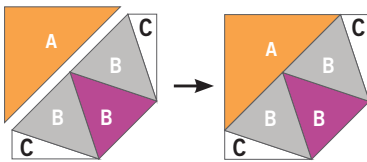

Sew A piece to the long edge of the C/B/B/B/C unit as shown. Make 4 units.

Step 5

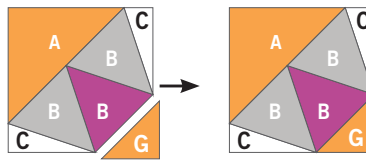

Sew G piece to the opposite edge of the A/C/B/B/B/C unit as shown. Make 4 units.

Step 6

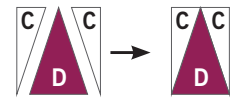

Sew a C piece to either side of 1 D piece shown to make a C/D/C unit. Make 4 units.

Step 7



In colors shown, sew 4 E pieces together to create E/E/E/E unit as shown. Make 4 units.

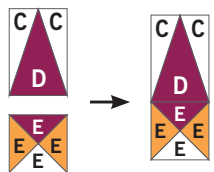

Sew C/D/C unit (from step 6) to E/E/E/E unit (from step 7) as shown. Make 4 units.

Step 9

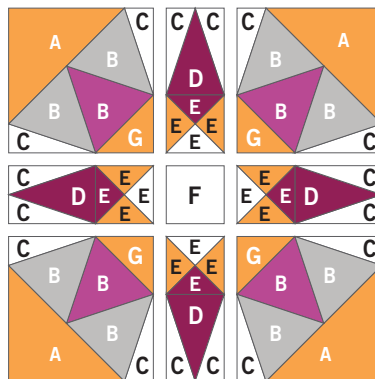

To complete block, lay out units from steps 5 and 8 with one F piece in the center. Sew units into rows, then sew rows together.

Step 10

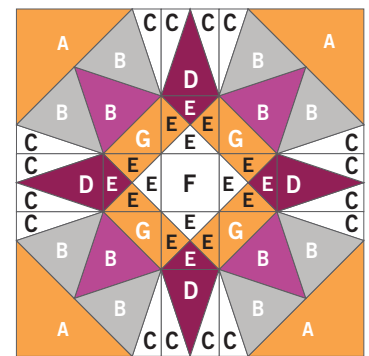

Block should measure 12½" square.



GO!® North Carolina Star-12" Finished

Item Number: 55605

North Carolina Star Quilt Block Colouring Page

Print out and colour as desired to test out different colour and fabric combinations.

